

CUSTOMER: **ELECTROIMPACT** CUSTOMER ORDER REF: **\*32433-00 ELECTROIMPACT**  
 DISTRIBUTOR: **ANDANTEX INCORPORATED** REDEX ORDER REF: **216793**  
 DESIGNATION: **KRP3+M.91.3.H.28/38** SERIAL NUMBER: **906768**  
 CODE: **RX129016-33** MOTOR FLANGE CODE: **RX129461-01**

EXTERNAL DIMENSIONS & INTERFACES: SN: **906768**

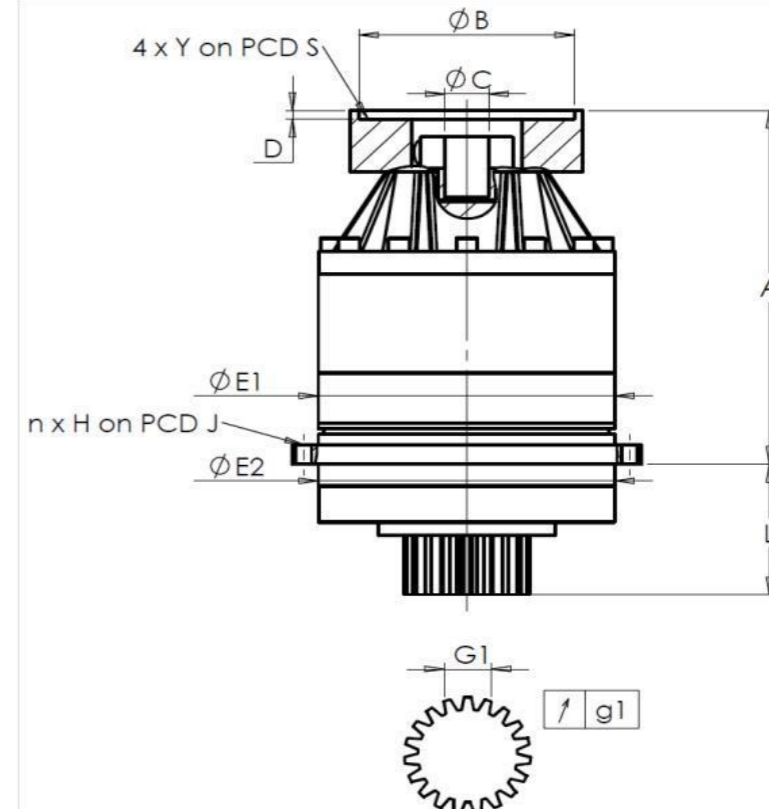

General tolerance: Js13 *Cmm* Automatic / manual coordinate-measuring machine  $\mu\text{m}$  Micrometer *Cr* Calliper rule *Di* Dial indicator *Pg* Plug gauge

For the installation, please refer to User Manual KRP (182/008)

SPECIFIC REMARKS:

HOUSING				OUTPUT PINION				MOTOR FLANGE			
requirement		measure		requirement		measure		requirement		measure	
		E8208				F891					
E1	255h7 <sup>0</sup> <sub>-0,052</sub> $\mu\text{m}$	254,99	Span dimension over 3 teeth				Ø B	131	$\mu\text{m}$	131	
E2	255h7 <sup>0</sup> <sub>-0,052</sub> $\mu\text{m}$	254,99	G1	39,25 <sup>0</sup> <sub>-0,03</sub> <i>Cmm</i>	39,235	Ø C	32 <sup>+0,05</sup> <sub>+0,025</sub> $\mu\text{m}$	32,05			
n x H on PCD J	16 Ø13,5 on PCD 280	<i>Cr</i> 16 Ø13,5 on PCD 280	g1	0,022	<i>Di</i> 0,01	Ø D	5	<i>Cr</i> 5,5			
A	313,5 $\mu\text{m}$	314,25	No-load input torque				Ø S1	165	<i>Cr</i> 165		
L	121 $\mu\text{m}$	121,05	Line 1		0,5 Nm	Ø Y1	M10	<i>Pg</i> M10			

			Noise level	
			@1600 rpm input (dB(A))	61,5
Torsional stiffness (Nm/arcmin)	1	473,03		
Radial stiffness (N/ $\mu\text{m}$ )	1	907		

Date: **29/07/2022**

Visa: **C DE MIRANDA**

Version: **A**

Product images are for illustrative purposes only.